

One-Click Cleaner Instruction Manual

SC/FC/ST

Thank you for choosing the **One-Click Cleaner SC/FC/ST**. The One-Click Cleaner SC/FC/ST is a **high-performance device designed for cleaning the ferrule end faces of SC/FC/ST connectors**. Please read this instruction manual carefully before using the device, and make sure to keep this manual for future reference.

1. Safety Precautions

While our device is considered safe, improper usage or mishandling can still result in injury to others. The One-Click Cleaner **SC/FC/ST** is **specifically designed for cleaning SC, FC and ST connectors only**. We are not responsible for any damage that may occur if this device is used for purposes other than its intended application.

2. Notes on Usage

- Do not** attempt to disassemble, as this can cause damage to the device.
- Do not** re-use the cleaning cloth, as this will eliminate its cleaning ability.
- Do not** touch the cleaning cloth, as this will cause contamination.
- Do not** pull on the cleaning cloth; use only the device body.
- Do not** use this cleaning cleaner when the cloth is empty, as this can cause damage to the connector.

3. Notes on Storage for Extended Periods

Do not expose the device to direct sunlight, high temperature or high humidity. The cover on the guide cap should be closed at all times when the device is not in use.

4. Device Construction

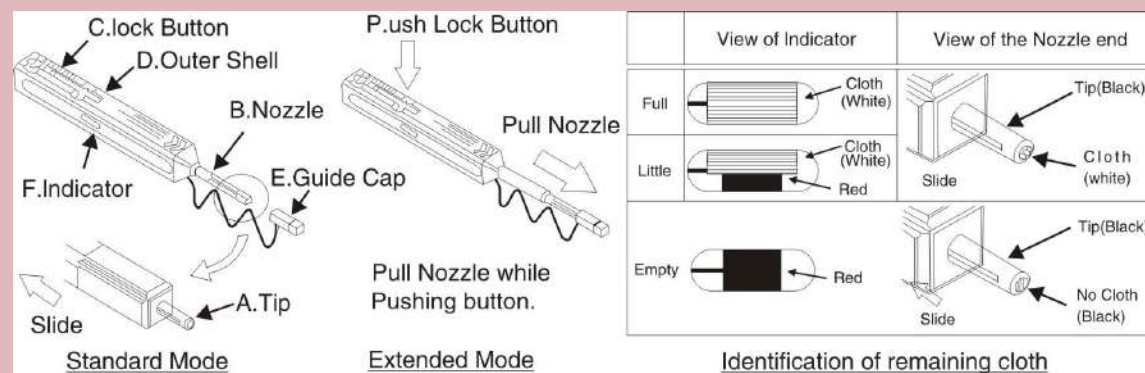

NO	Part Name	Function
A	Tip	Lead the cleaning cloth to the optical connector end face.
B	Nozzle	Lead tip to the optical connector end face.
C	Lock Button	Push the button to extend and contract the nozzle.
D	Outer Shell	Push the outer shell to clean the connector.
E	Guide Cap	Acts as dust cap or cleaning adaptor for connector plug.
F	Indicator	Provides indication of remaining cleaning cloth

5. Applications

<Connector inside adaptor>

1. Remove Guide Cap from the device

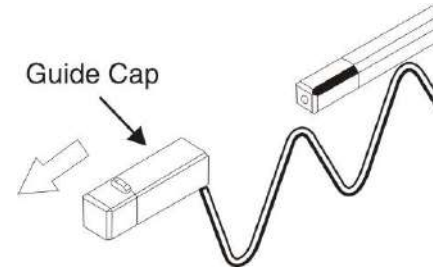

2. Insert tip of cleaner into SC/FC/ST Adaptor

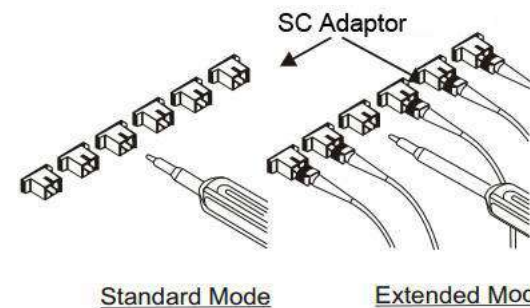

3. Push the Outer Shell to start cleaning the SC/FC/ST connector end face. A "click" sound indicates end of cleaning process. Close the cover after use.

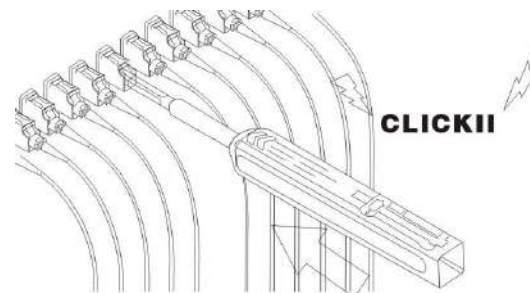

Be careful **not to slant** the One-Click Cleaner while inserting it into the adaptor. **Avoid applying excessive force during insertion**, as this may cause damage to both the connector and the One-Click Cleaner SC/FC/ST. If you encounter resistance while pushing the outer shell, remove the One-Click Cleaner from the adaptor and ensure that there are no large debris particles obstructing the cleaning process.

<Connector plugs alone>

1. Open the Cover on the Guide Cap

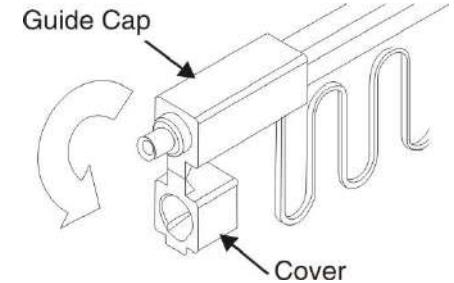

2. Insert SC/FC/ST connector into the Guide

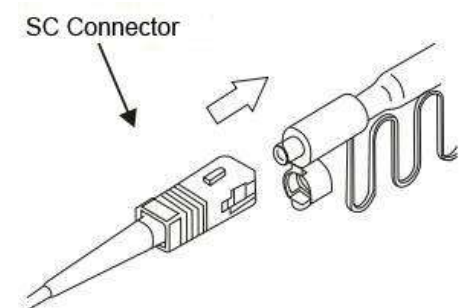

3. Push the Outer Shell to start cleaning the SC/FC/ST connector end face. A "click" sound indicates end of cleaning process. Close the cover after use.

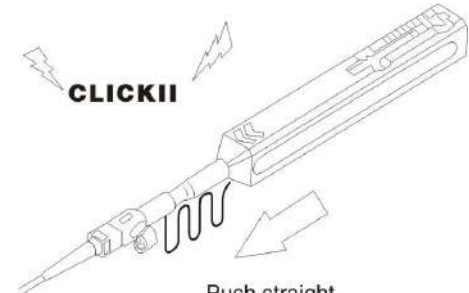

Be careful **not to slant** the SC/FC/ST connector while inserting it into the guide cap. **Avoid applying excessive force during insertion**, as this may damage both the connector and the One-Click Cleaner SC/FC/ST. If you encounter resistance while pushing the outer shell, remove the One-Click Cleaner from the connector and ensure there are no large debris particles obstructing the cleaning process.